

**KRISTJAN PALUSALU XIX MÄLESTUSVÕISTLUSED KREEKA-ROOMA
MAADLUSES
TALLINN
27.-28.10.2006**

55 kg

- 1 GASIMOV, SHAKHIN (RUS)
- 2 AUDICKAS, ANTON (LIT)
- 3 WOLFGANG, VICTOR (SWE)
- 3 DZANVELIAN, EDUARD (RUS)
- 5 ZEINALOV, ANAR (EST)
- 6 TEPLYASHIM, EVGENY (RUS)

60 kg

- 1 DENISOW, YRIA (RUS)
- 2 UIMONEN, ESA (FIN)
- 3 NEMCHENKO, OLEG (RUS)
- 3 EDZHIBADZE, TEUMURAZ (RUS)
- 5 LÄÄTS, INDREK (EST)
- 5 TURTIAINEN, VILLE (FIN)
- 7 RIS, JOHAN (SWE)
- 8 ZJATKOV, ANDREJS (LAT)

66 kg

- 1 EMIR-AMŠAEV, RUSTEM (RUS)
- 2 TOIJANEN, RAFAEL (FIN)
- 3 POGUDIN, VLADIMIR (RUS)
- 3 KALLASMAA, MARTIN (EST)
- 5 KOSKINEN, MIKKO (FIN)
- 5 HOLM, URBAU (SWE)
- 7 PALOMÄKI, HENRI (FIN)
- 8 SKONOBOGATOV, PAVEL (RUS)
- 9 ZUZAVLOV, MAKSIM (LAT)
- 10 MITT, ARGO (EST)
- 11 VARDANYAN, SHARUN (SWE)
- 12 TUULENSUU, JONI (FIN)
- 13 KACHAJEV, ANTON (EST)
- 14 MAGVAN, AMIRKHANI (FIN)
- 15 AHONEN, RAMI (FIN)
- 16 SUNDBERG, JOSEF (SWE)
- 17 KOVALOV, VIKTORS (LAT)

74 kg

- 1 LUNDELL, TOMMY (SWE)
- 2 NOVIKOV, VADIM (RUS)
- 3 APS, EERIK (EST)
- 3 MAHUKIOAH, GAGIK (RUS)
- 5 HAKANSON, JOHAN (SWE)
- 5 TUOMELA, MARKO (FIN)
- 7 MOTOVILOV, PETR (RUS)
- 8 HAKALA, HENRY (FIN)
- 9 AMIRKHANI, ARESH (FIN)
- 10 VISNAKOUS, ALEKSANDRS (LAT)
- 11 GABRANS, KONSTANTIN (LAT)
- 12 PRIKULIS, ANDREJS (LAT)
- 13 LINTALA, TONI (FIN)
- 14 HUHTAMÄKI, JOONA (FIN)
- 15 ANKKURI, MIKKO (FIN)
- 16 SAARIAHO, JUHA-MATTI (FIN)
- 17 MÄKINEN, JANNE (FIN)
- 18 UKKOLA, JONNE (FIN)

84 kg

- 1 TOOM, ALO (EST)
- 2 SCHÖN, FREDRIK (SWE)
- 3 ZHARAKHOV, GASAN (RUS)
- 3 NOVOZHILOV, DENIS (RUS)
- 5 RESETNIKOV, ILJA (LAT)
- 5 MOISIO, VALTTERI (FIN)
- 7 BOGDANOV, MIHAILS (LAT)
- 8 KOTKAS, IVAR (EST)
- 9 ALAK, ERKKI (EST)
- 10 NAARITS, TÖNIS (EST)
- 11 LJUNGBÄCK, CHRISTOFFER (SWE)
- 12 THOMBERG, TARVI (EST)
- 13 ORELL, TINO (FIN)
- 14 JOKIN, JONNE (FIN)
- 15 KULIKOV, STANISLAVS (LAT)
- 16 KURONEN, MIKA (FIN)
- 17 PIIR, HENRY (EST)
- 18 VÄLIMÄKI, HENRI (FIN)
- 19 SUTINEN, MARKUS (FIN)
- 20 KREHHOV, KONSTANTIN (EST)

96 kg

- 1 MAKEEV, ANATOLI (RUS)
- 2 MIKAJA, GEORGI (RUS)
- 3 THOMBERG, RAIT (EST)
- 3 MAURER, KAROL (EST)
- 5 PIETILÄ, PASI (FIN)
- 5 HÄMÄLÄINEN, MATTI (FIN)
- 7 RINTAMÄKI, PEKKA (FIN)
- 8 LUKOŠAITIS, ALDAS (LIT)
- 9 LÖNNBORN, SEBASTIAN (SWE)
- 10 SUOMINEN, MIKKO (FIN)

120 kg

- 1 EUREN, JOHAN (SWE)
- 2 HIETANIEMI, RAMI ANTERO (FIN)
- 3 KABULOV, ATSAMAZ (RUS)
- 3 SOOPART, HEIKO (EST)
- 5 PETRENKO, OLEKSANDR (UKR)
- 5 VIIRG, PRIIT (EST)
- 7 SJÖBERG, JALMAR (SWE)
- 8 RIIHIOJA, OSKARI (FIN)
- 9 SIHIMETS, MADIS (EST)

100 kg Kadetid

- 1 LALLI, TAISTO (FIN)
- 2 UZDENOV, SULTANBEK (RUS)
- 3 LIPANIN, ALEKSEI (RUS)
- 4 KÖLUVERE, RAIVO (EST)

CHIEF OF OFFICIALS MATI RAND

CHIEF OF SECRETARY ENN TÕNISSON

**KRISTJAN PALUSALU XIX MÄLESTUSVÕISTLUSED KREEKA-ROOMA MAADLUSES
TALLINN
27.-28.10.2006**

Weight category Kaal 55 kg

Place Koht	Tour Préliminaire Eelring	1/2 Finale 1/2 Finaal	Finale 1.-2. Finaal 1.-2.						
3	1 WOLFGANG, VICTOR (SWE)	1 WOLFGANG, VICTOR (SWE) <table border="1"><tr><td>1</td><td>1</td></tr></table>	1	1	2 AUDICKAS, ANTON (LIT) <table border="1"><tr><td>1</td><td>1</td></tr></table>	1	1		
1	1								
1	1								
2	2 AUDICKAS, ANTON (LIT)	2 AUDICKAS, ANTON (LIT) <table border="1"><tr><td>3</td><td>5</td></tr></table>	3	5					
3	5								
5	3 ZEINALOV, ANAR (EST) <table border="1"><tr><td>1</td><td>1</td></tr></table>	1	1	4 GASIMOV, SHAKHIN (RUS) <table border="1"><tr><td>3</td><td>6</td></tr></table>	3	6	4 GASIMOV, SHAKHIN (RUS) <table border="1"><tr><td>3</td><td>10</td></tr></table>	3	10
1	1								
3	6								
3	10								
1	4 GASIMOV, SHAKHIN (RUS) <table border="1"><tr><td>3</td><td>4</td></tr></table>	3	4						
3	4								
6 <table border="1"><tr><td>0</td><td>0</td></tr></table>	0	0	5 TEPLYASHIM, EVGENY (RUS) <table border="1"><tr><td>0</td><td>0</td></tr></table>	0	0	6 DZANVELIAN, EDUARD (RUS) <table border="1"><tr><td>1</td><td>1</td></tr></table>	1	1	
0	0								
0	0								
1	1								
3	6 DZANVELIAN, EDUARD (RUS) <table border="1"><tr><td>3</td><td>13</td></tr></table>	3	13						
3	13								

4 GASIMOV, SHAKHIN (RUS)

REPECHAGE			
Perdants contre le 1er Finaliste Esimesele finalistile kaotajad	Perdants contre le 2ème Finaliste Teisele finalistile kaotajad		
1 WOLFGANG, VICTOR (SWE)	3 ZEINALOV, ANAR (EST) <table border="1"><tr><td>0</td><td>0</td></tr></table>	0	0
0	0		
↑ Médaille de Bronze Pronksmedali võitja	6 DZANVELIAN, EDUARD (RUS) <table border="1"><tr><td>5</td><td>9</td></tr></table>	5	9
5	9		
	↑ Médaille de Bronze Pronksmedali võitja		

CHIEF OF OFFICIALS
CHIEF OF SECRETARY

MATI RAND
ENN TÕNISSON

**KRISTJAN PALUSALU XIX MÄLESTUSVÖISTLUSED KREEKA-ROOMA MAADLUSES
TALLINN
27.-28.10.2006**

Weight category Kaal 60 kg

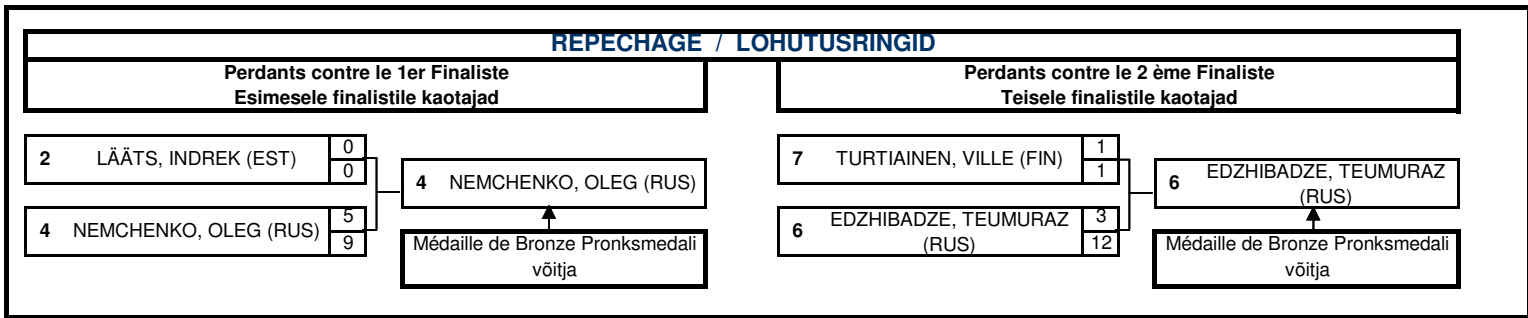
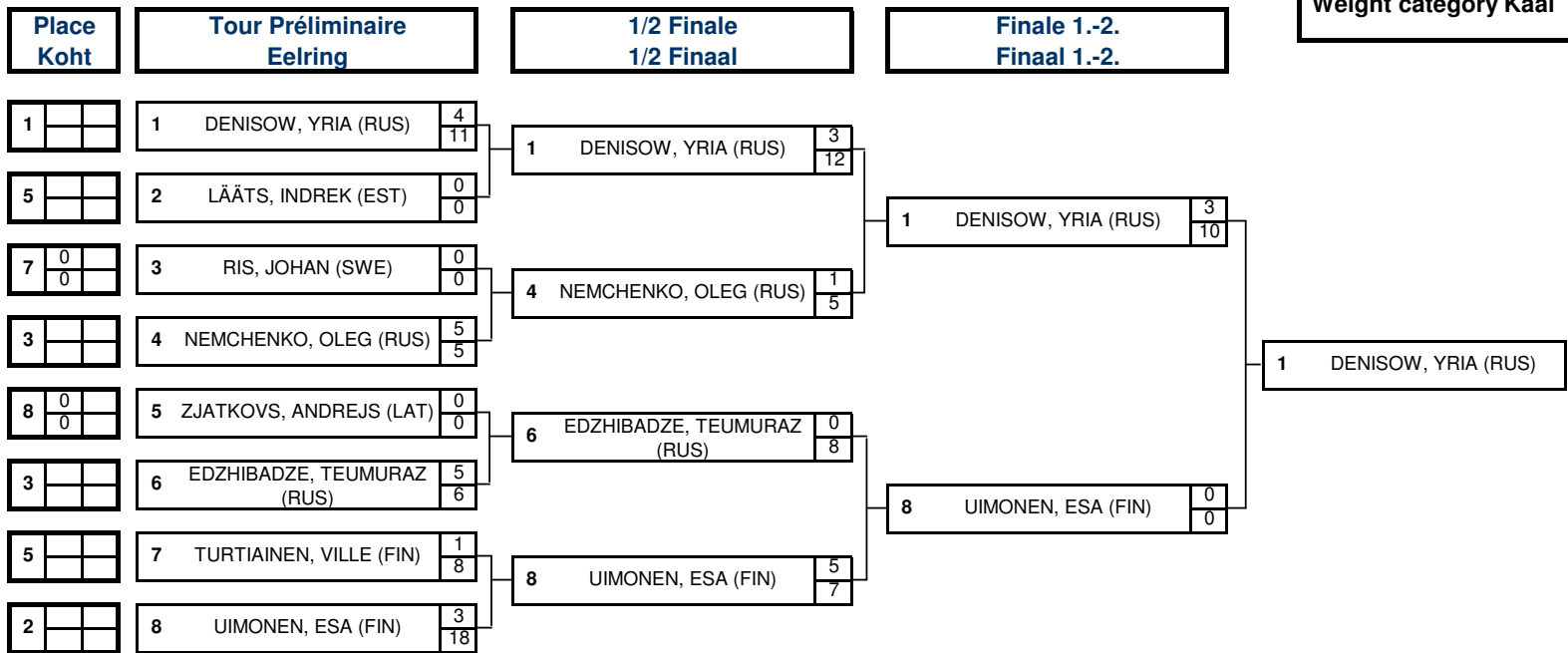

CHIEF OF OFFICIALS MATI RAND
CHIEF OF SECRETARY ENN TÕNISSON

KRISTJAN PALUSALU XIX MÄLESTUSVÕISTLUSED KREEKA-ROOMA MAADLUSES
TALLINN
27.-28.10.2006

Place Koht	Tour Préliminaire Eelring	1/8 Finale 1/8 Finaal	1/4 Finale 1/4 Finaal	1/2 Finale 1/2 Finaal	Finale 1.-2. Finaal 1.-2.						
5	1 KOSKINEN, MIKKO (FIN)	1 KOSKINEN, MIKKO (FIN) 3 10	1 KOSKINEN, MIKKO (FIN) 5 6	1 KOSKINEN, MIKKO (FIN) 1 2	Weight category Kaal 66 kg <div style="display: flex; justify-content: space-around; align-items: center;"> <div style="text-align: center;"> <table border="1" style="border-collapse: collapse;"> <tr><td>5</td><td>TOIJANEN, RAFAEL (FIN)</td><td style="text-align: right;">1 1</td></tr> </table> </div> <div style="text-align: center;"> <table border="1" style="border-collapse: collapse;"> <tr><td>14</td><td>EMIR-AMŠAEV, RUSTEM (RUS)</td><td style="text-align: right;">4 12</td></tr> </table> </div> </div>	5	TOIJANEN, RAFAEL (FIN)	1 1	14	EMIR-AMŠAEV, RUSTEM (RUS)	4 12
5	TOIJANEN, RAFAEL (FIN)	1 1									
14	EMIR-AMŠAEV, RUSTEM (RUS)	4 12									
12	2 TUULENSUU, JONI (FIN)	2 TUULENSUU, JONI (FIN) 1 5	3 SKONOBOGATOV, PAVEL (RUS) 0 10	5 TOIJANEN, RAFAEL (FIN) 3 4							
8	3 SKONOBOGATOV, PAVEL (RUS)	3 SKONOBOGATOV, PAVEL (RUS) 3 10	7 POGUDIN, VLADIMIR (RUS) 1 6	9 HOLM, URBAU (SWE) 1 1							
14	4 MAGVAN, AMIRKHANI (FIN)	4 MAGVAN, AMIRKHANI (FIN) 1 2	9 HOLM, URBAU (SWE) 3 10	14 EMIR-AMŠAEV, RUSTEM (RUS) 4 12							
2	5 TOIJANEN, RAFAEL (FIN)	5 TOIJANEN, RAFAEL (FIN) 3 11	12 PALOMÄKI, HENRI (FIN) 1 1	14 EMIR-AMŠAEV, RUSTEM (RUS) 3 9							
10	6 MITT, ARGO (EST)	6 MITT, ARGO (EST) 1 2	14 EMIR-AMŠAEV, RUSTEM (RUS) 4 12	15 KALLASMAA, MARTIN (EST) 0 0							
3	7 POGUDIN, VLADIMIR (RUS)	7 POGUDIN, VLADIMIR (RUS) 3 5	15 KALLASMAA, MARTIN (EST) 3 5	16 KACHAJEV, ANTON (EST) 1 4							
11	8 VARDANYAN, SHARUN (SWE)	8 VARDANYAN, SHARUN (SWE) 1 7	17 ZUZAVLOV, MAKSIM (LAT) 0 0	17 ZUZAVLOV, MAKSIM (LAT) 3 9							
5	9 HOLM, URBAU (SWE)	9 HOLM, URBAU (SWE) 4 14									
17	10 KOVALOV, VIKTORS (LAT)	10 KOVALOV, VIKTORS (LAT) 0 0									
15	11 AHONEN, RAMI (FIN)	11 AHONEN, RAMI (FIN) 1 1									
7	12 PALOMÄKI, HENRI (FIN)	12 PALOMÄKI, HENRI (FIN) 3 8									
16	13 SUNDBERG, JOSEF (SWE)	13 SUNDBERG, JOSEF (SWE) 0 0									
1	14 EMIR-AMŠAEV, RUSTEM (RUS)	14 EMIR-AMŠAEV, RUSTEM (RUS) 5 9									
3	15 KALLASMAA, MARTIN (EST)	15 KALLASMAA, MARTIN (EST) 3 5									
13	16 KACHAJEV, ANTON (EST) 1 4										
9	17 ZUZAVLOV, MAKSIM (LAT) 3 9										

CHIEF OF OFFICIALS
CHIEF OF SECRETARY

MATI RAND
ENN TÕNISSON

REPECHAGE / LOHUTUSRINGID

**Perdants contre le 1er Finaliste
Esimesele finalistile kaotajad**

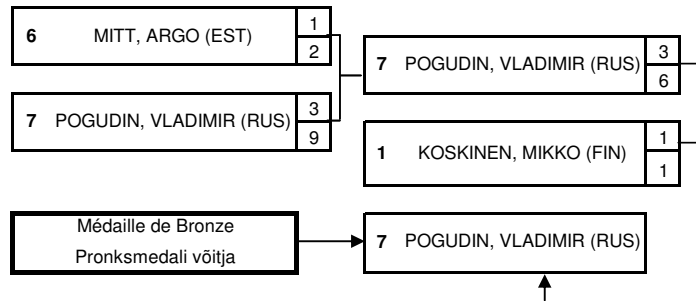

Weight category

Kaal

66 kg

**Perdants contre le 2ème Finaliste
Teisele finalistile kaotajad**

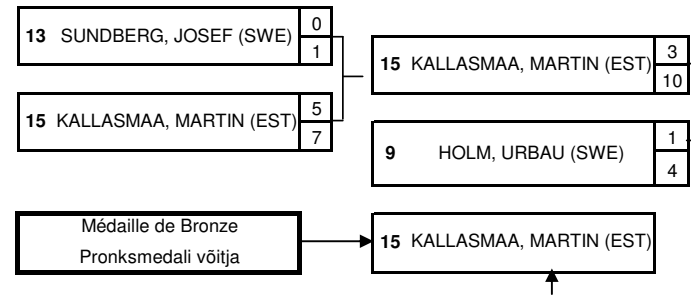

KRISTJAN PALUSALU XIX MÄLESTUSVÕISTLUSED KREEKA-ROOMA MAADLUSES

TALLINN

27.-28.10.2006

Place Koht	Tour Préliminaire Eelring	1/8 Finale 1/8 Finaal	1/4 Finale 1/4 Finaal	1/2 Finale 1/2 Finaal	Finale 1.-2. Finaal 1.-2.
15 0 0 8	1 ANKKURI, MIKKO (FIN)	1 ANKKURI, MIKKO (FIN) 0 0	2 APS, EERIK (EST) 3 9	2 APS, EERIK (EST) 1 7	<p>Weight category Kaal 74 kg</p> <p>6 NOVIKOV, VADIM (RUS) 1 4</p> <p>18 LUNDELL, TOMMY (SWE)</p> <p>6 NOVIKOV, VADIM (RUS) 3 6</p> <p>12 MAHUKIOAH, GAGIK (RUS) 1 6</p> <p>18 LUNDELL, TOMMY (SWE) 3 3</p> <p>18 LUNDELL, TOMMY (SWE) 3 4</p> <p>CHIEF OF OFFICIALS CHIEF OF SECRETARY</p> <p>MATI RAND ENN TÕNISSON</p>
3	2 APS, EERIK (EST)	2 APS, EERIK (EST) 3 8	4 HAKALA, HENRY (FIN) 1 5	6 NOVIKOV, VADIM (RUS) 3 8	
14 0 0 7	3 HUHTAMÄKI, JOONA (FIN)	3 HUHTAMÄKI, JOONA (FIN) 0 0	6 NOVIKOV, VADIM (RUS) 3 9	7 AMIRKHANI, ARESH (FIN) 0 0	
8 4 12	4 HAKALA, HENRY (FIN)	4 HAKALA, HENRY (FIN) 3 7	7 AMIRKHANI, ARESH (FIN) 3 9	8 PRIKULIS, ANDREJS (LAT) 1 2	
5	5 HAKANSON, JOHAN (SWE)	5 HAKANSON, JOHAN (SWE) 0 0	10 VISNAKOUS, ALEKSANDRS (LAT) 0 0	11 GABRANS, KONSTANTIN (LAT) 1 9	
2	6 NOVIKOV, VADIM (RUS)	6 NOVIKOV, VADIM (RUS) 3 9	12 MAHUKIOAH, GAGIK (RUS) 5 0	12 MAHUKIOAH, GAGIK (RUS) 3 12	
9 4 10	7 AMIRKHANI, ARESH (FIN)	7 AMIRKHANI, ARESH (FIN) 3 9	14 MOTOVILOV, PETR (RUS) 0 5	14 MOTOVILOV, PETR (RUS) 0 5	
12 1 2	8 PRIKULIS, ANDREJS (LAT)	8 PRIKULIS, ANDREJS (LAT) 1 2	18 LUNDELL, TOMMY (SWE) 5 13	18 LUNDELL, TOMMY (SWE) 3 4	
13 1 2	9 LINTALA, TONI (FIN)	9 LINTALA, TONI (FIN) 1 2	18 LUNDELL, TOMMY (SWE) 3 6		
10 3 3	10 VISNAKOUS, ALEKSANDRS (LAT)	10 VISNAKOUS, ALEKSANDRS (LAT) 3 3			
11 1 9	11 GABRANS, KONSTANTIN (LAT)	11 GABRANS, KONSTANTIN (LAT) 1 9			
3	12 MAHUKIOAH, GAGIK (RUS)	12 MAHUKIOAH, GAGIK (RUS) 3 12			
18 0 0 15	13 UKKOLA, JONNE (FIN)	13 UKKOLA, JONNE (FIN) 0 0			
7 5 29	14 MOTOVILOV, PETR (RUS)	14 MOTOVILOV, PETR (RUS) 4 15			
16 0 0 9	15 SAARIAHO, JUHA-MATTI (FIN) 0 0	16 TUOMELA, MARKO (FIN) 1 7			
5	16 TUOMELA, MARKO (FIN) 3 9	18 LUNDELL, TOMMY (SWE) 3 6			
17 0 0 9	17 MÄKINEN, JANNE (FIN) 0 0				
1	18 LUNDELL, TOMMY (SWE) 3 9				

REPECHAGE / LOHUTUSRINGID

Weight category

Kaal

74 kg

**Perdants contre le 1er Finaliste
Esimesele finalistile kaotajad**

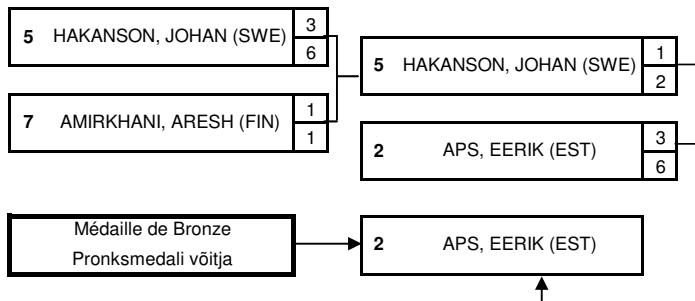

**Perdants contre le 2ème Finaliste
Teisele finalistile kaotajad**

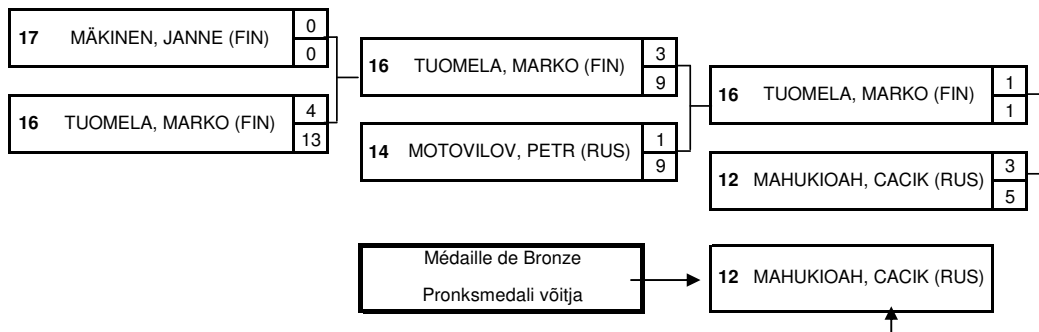

CHIEF OF OFFICIALS

MATI RAND

CHIEF OF SECRETARY

ENN TÕNISSON

**KRISTJAN PALUSALU XIX MÄLESTUSVÕISTLUSED KREEKA-ROOMA MAADLUSES
TALLINN
27.-28.10.2006**

Place Koht	Tour Préliminaire Eelring	1/8 Finale 1/8 Finaal	1/4 Finale 1/4 Finaal	1/2 Finale 1/2 Finaal	Finale 1.-2. Finaal 1.-2.
					Weight category Kaal 84 kg
14	1 JOKIN, JONNE (FIN)	1 JOKIN, JONNE (FIN)	2 NAARITS, TÕNIS (EST)	4 TOOM, ALO (EST)	4 TOOM, ALO (EST)
10	2 NAARITS, TÕNIS (EST)	2 NAARITS, TÕNIS (EST)	4 TOOM, ALO (EST)	4 TOOM, ALO (EST)	4 TOOM, ALO (EST)
3	3 ZHARAKHOV, GASAN (RUS)	3 ZHARAKHOV, GASAN (RUS)	4 TOOM, ALO (EST)	4 TOOM, ALO (EST)	4 TOOM, ALO (EST)
1	4 TOOM, ALO (EST)	4 TOOM, ALO (EST)	4 TOOM, ALO (EST)	4 TOOM, ALO (EST)	4 TOOM, ALO (EST)
8	5 KOTKAS, IVAR (EST)	5 KOTKAS, IVAR (EST)	5 KOTKAS, IVAR (EST)	5 KOTKAS, IVAR (EST)	5 KOTKAS, IVAR (EST)
15	6 KULIKOV, STANISLAVS (LAT)	6 KULIKOV, STANISLAVS (LAT)	6 KULIKOV, STANISLAVS (LAT)	7 RESETNIKOVS, ILJA (LAT)	7 RESETNIKOVS, ILJA (LAT)
5	7 RESETNIKOVS, ILJA (LAT)	7 RESETNIKOVS, ILJA (LAT)	7 RESETNIKOVS, ILJA (LAT)	7 RESETNIKOVS, ILJA (LAT)	7 RESETNIKOVS, ILJA (LAT)
16	8 KURONEN, MIKA (FIN)	8 KURONEN, MIKA (FIN)	8 KURONEN, MIKA (FIN)	8 KURONEN, MIKA (FIN)	8 KURONEN, MIKA (FIN)
2	9 SCHÖN, FREDRIK (SWE)	9 SCHÖN, FREDRIK (SWE)	9 SCHÖN, FREDRIK (SWE)	9 SCHÖN, FREDRIK (SWE)	9 SCHÖN, FREDRIK (SWE)
13	10 ORELL, TINO (FIN)	10 ORELL, TINO (FIN)	10 ORELL, TINO (FIN)	9 SCHÖN, FREDRIK (SWE)	9 SCHÖN, FREDRIK (SWE)
3	11 NOVOZHILOV, DENIS (RUS)	11 NOVOZHILOV, DENIS (RUS)	11 NOVOZHILOV, DENIS (RUS)	11 NOVOZHILOV, DENIS (RUS)	11 NOVOZHILOV, DENIS (RUS)
18	12 VÄLIMÄKI, HENRI (FIN)	12 VÄLIMÄKI, HENRI (FIN)	12 VÄLIMÄKI, HENRI (FIN)	12 VÄLIMÄKI, HENRI (FIN)	12 VÄLIMÄKI, HENRI (FIN)
5	13 MOISIO, VALTTERI (FIN)	13 MOISIO, VALTTERI (FIN)	13 MOISIO, VALTTERI (FIN)	13 MOISIO, VALTTERI (FIN)	9 SCHÖN, FREDRIK (SWE)
20	14 KREHHOV, KONSTANTIN (EST)	14 KREHHOV, KONSTANTIN (EST)	13 MOISIO, VALTTERI (FIN)	13 MOISIO, VALTTERI (FIN)	9 SCHÖN, FREDRIK (SWE)
12	15 THOMBERG, TARVI (EST)	15 THOMBERG, TARVI (EST)	16 LJUNGBÄCK, CHRISTOFFER (SWE)	13 MOISIO, VALTTERI (FIN)	9 SCHÖN, FREDRIK (SWE)
11	16 LJUNGBÄCK, CHRISTOFFER (SWE)	16 LJUNGBÄCK, CHRISTOFFER (SWE)	16 LJUNGBÄCK, CHRISTOFFER (SWE)	13 MOISIO, VALTTERI (FIN)	9 SCHÖN, FREDRIK (SWE)
17	17 PIIR, HENRY (EST)	17 PIIR, HENRY (EST)	18 BOGDANOV, MIHAILS (LAT)	13 MOISIO, VALTTERI (FIN)	9 SCHÖN, FREDRIK (SWE)
7	18 BOGDANOV, MIHAILS (LAT)	18 BOGDANOV, MIHAILS (LAT)	18 BOGDANOV, MIHAILS (LAT)	13 MOISIO, VALTTERI (FIN)	9 SCHÖN, FREDRIK (SWE)
9	19 ALAK, ERKKI (EST)	19 ALAK, ERKKI (EST)	18 BOGDANOV, MIHAILS (LAT)	13 MOISIO, VALTTERI (FIN)	9 SCHÖN, FREDRIK (SWE)
19	20 SUTINEN, MARKUS (FIN)	20 SUTINEN, MARKUS (FIN)	19 ALAK, ERKKI (EST)	13 MOISIO, VALTTERI (FIN)	9 SCHÖN, FREDRIK (SWE)

CHIEF OF OFFICIALS
CHIEF OF SECRETARY

MATI RAND
ENN TÕNISSON

REPECHAGE / LOHUTUSRINGID

Weight category

Kaal

84 kg

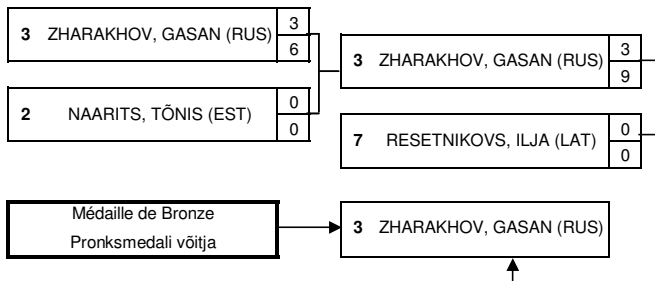
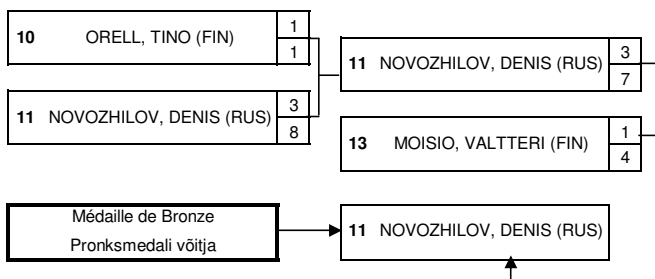
Perdants contre le 1er Finaliste**Esimesele finalistile kaotajad****Perdants contre le 2ème Finaliste****Teisele finalistile kaotajad**

**KRISTJAN PALUSALU XIX MÄLESTUSVÕISTLUSED KREEKA-ROOMA MAADLUSES
TALLINN
27.-28.10.2006**

Weight category Kaal 96 kg

Place Koht	Tour Préliminaire Eelring	1/4 Finale 1/4 Finaal	1/2 Finale 1/2 Finaal	Finale 1.-2. Finaal 1.-2.						
2	1 MIKAJA, GEORGI (RUS)	1 MIKAJA, GEORGI (RUS) <table border="1"><tr><td>4</td><td>11</td></tr></table>	4	11	1 MIKAJA, GEORGI (RUS) <table border="1"><tr><td>3</td><td>4</td></tr></table>	3	4	1 MIKAJA, GEORGI (RUS) <table border="1"><tr><td>0</td><td>0</td></tr></table>	0	0
4	11									
3	4									
0	0									
3	2 THOMBERG, RAIT (EST)	2 THOMBERG, RAIT (EST) <table border="1"><tr><td>1</td><td>1</td></tr></table>	1	1						
1	1									
5	3 PIETILÄ, PASI (FIN)	3 PIETILÄ, PASI (FIN) <table border="1"><tr><td>5</td><td>10</td></tr></table>	5	10	3 PIETILÄ, PASI (FIN) <table border="1"><tr><td>1</td><td>1</td></tr></table>	1	1			
5	10									
1	1									
10	4 SUOMINEN, MIKKO (FIN)	4 SUOMINEN, MIKKO (FIN) <table border="1"><tr><td>0</td><td>0</td></tr></table>	0	0						
0	0									
5	5 HÄMÄLÄINEN, MATTI (FIN)	5 HÄMÄLÄINEN, MATTI (FIN) <table border="1"><tr><td>0</td><td>0</td></tr></table>	0	0	6 MAKEEV, ANATOLI (RUS) <table border="1"><tr><td>5</td><td>0</td></tr></table>	5	0	6 MAKEEV, ANATOLI (RUS) <table border="1"><tr><td>3</td><td>6</td></tr></table>	3	6
0	0									
5	0									
3	6									
1	6 MAKEEV, ANATOLI (RUS)	6 MAKEEV, ANATOLI (RUS) <table border="1"><tr><td>3</td><td>10</td></tr></table>	3	10						
3	10									
9	7 LÖNNBORN, SEBASTIAN (SWE)	8 RINTAMÄKI, PEKKA (FIN) <table border="1"><tr><td>1</td><td>2</td></tr></table>	1	2	9 MAURER, KAROL (EST) <table border="1"><tr><td>0</td><td>0</td></tr></table>	0	0			
1	2									
0	0									
7	8 RINTAMÄKI, PEKKA (FIN)	8 RINTAMÄKI, PEKKA (FIN) <table border="1"><tr><td>3</td><td>5</td></tr></table>	3	5						
3	5									
3	9 MAURER, KAROL (EST)	9 MAURER, KAROL (EST) <table border="1"><tr><td>3</td><td>10</td></tr></table>	3	10						
3	10									
8	10 LUKOŠAITIS, ALDAS (LIT)	10 LUKOŠAITIS, ALDAS (LIT) <table border="1"><tr><td>1</td><td>12</td></tr></table>	1	12						
1	12									

REPECHAGE / LOHUTUSRINGID					
Perdants contre le 1er Finaliste Esimesele finalistile kaotajad	Perdants contre le 2ème Finaliste Teisele finalistile kaotajad				
<table border="1"><tr><td> </td><td> </td></tr></table>			<table border="1"><tr><td> </td><td> </td></tr></table>		
<table border="1"><tr><td> </td><td> </td></tr></table>			<table border="1"><tr><td> </td><td> </td></tr></table>		
2 THOMBERG, RAIT (EST) <table border="1"><tr><td>3</td><td>12</td></tr></table>	3	12	5 HÄMÄLÄINEN, MATTI (FIN) <table border="1"><tr><td>1</td><td>2</td></tr></table>	1	2
3	12				
1	2				
3 PIETILÄ, PASI (FIN) <table border="1"><tr><td>1</td><td>4</td></tr></table>	1	4	9 MAURER, KAROL (EST) <table border="1"><tr><td>3</td><td>6</td></tr></table>	3	6
1	4				
3	6				
Médaille de Bronze Pronksmedali võitja → 2 THOMBERG, RAIT (EST)	Médaille de Bronze Pronksmedali võitja → 9 MAURER, KAROL (EST)				

CHIEF OF OFFICIALS
CHIEF OF SECRETARY

MATI RAND
ENN TÕNISSON

**KRISTJAN PALUSALU XIX MÄLESTUSVÕISTLUSED KREEKA-ROOMA MAADLUSES
TALLINN
27.-28.10.2006**

Weight category Kaal 120 kg

Place Koht	Tour Préliminaire Eelring	1/4 Finale 1/4 Finaal	1/2 Finale 1/2 Finaal	Finale 1.-2. Finaal 1.-2.								
1	1 EUREN, JOHAN (SWE)	1 EUREN, JOHAN (SWE) <table border="1"><tr><td>3</td><td>8</td></tr></table>	3	8	1 EUREN, JOHAN (SWE) <table border="1"><tr><td>3</td><td>7</td></tr></table>	3	7	1 EUREN, JOHAN (SWE) <table border="1"><tr><td>3</td><td>10</td></tr></table>	3	10		
3	8											
3	7											
3	10											
3	2 KABULOV, ATSAMAZ (RUS)	2 KABULOV, ATSAMAZ (RUS) <table border="1"><tr><td>1</td><td>2</td></tr></table>	1	2	4 PETRENKO, OLEKSANDR (UKR) <table border="1"><tr><td>1</td><td>5</td></tr></table>	1	5					
1	2											
1	5											
9	3 SIHIMETS, MADIS (EST) <table border="1"><tr><td>0</td><td>0</td></tr></table>	0	0	3 SIHIMETS, MADIS (EST) <table border="1"><tr><td>0</td><td>0</td></tr></table>	0	0	6 VIIRG, PRIIT (EST) <table border="1"><tr><td>0</td><td>0</td></tr></table>	0	0	9 HIETANIEMI, RAMI ANTERO (FIN) <table border="1"><tr><td>1</td><td>4</td></tr></table>	1	4
0	0											
0	0											
0	0											
1	4											
5	4 PETRENKO, OLEKSANDR (UKR)	4 PETRENKO, OLEKSANDR (UKR) <table border="1"><tr><td>5</td><td>3</td></tr></table>	5	3	9 HIETANIEMI, RAMI ANTERO (FIN) <table border="1"><tr><td>5</td><td>4</td></tr></table>	5	4					
5	3											
5	4											
8	5 RIIHIOJA, OSKARI (FIN) <table border="1"><tr><td>0</td><td>2</td></tr></table>	0	2	5 RIIHIOJA, OSKARI (FIN) <table border="1"><tr><td>0</td><td>2</td></tr></table>	0	2						
0	2											
0	2											
5	6 VIIRG, PRIIT (EST)	6 VIIRG, PRIIT (EST) <table border="1"><tr><td>5</td><td>3</td></tr></table>	5	3								
5	3											
7	7 SJÖBERG, JALMAR (SWE) <table border="1"><tr><td>1</td><td>4</td></tr></table>	1	4	7 SJÖBERG, JALMAR (SWE) <table border="1"><tr><td>1</td><td>4</td></tr></table>	1	4						
1	4											
1	4											
3	8 SOOPART, HEIKO (EST) <table border="1"><tr><td>1</td><td>1</td></tr></table>	1	1	9 HIETANIEMI, RAMI ANTERO (FIN) <table border="1"><tr><td>3</td><td>5</td></tr></table>	3	5						
1	1											
3	5											
2	9 HIETANIEMI, RAMI ANTERO (FIN) <table border="1"><tr><td>3</td><td>6</td></tr></table>	3	6									
3	6											

REPECHAGE / LOHUTUSRINGID									
Perdants contre le 1er Finaliste Esimesele finalistile kaotajad		Perdants contre le 2ème Finaliste Teisele finalistile kaotajad							
	2 KABULOV, ATSAMAZ (RUS) <table border="1"><tr><td>3</td><td>5</td></tr></table>	3	5	8 SOOPART, HEIKO (EST) <table border="1"><tr><td>5</td><td>0</td></tr></table>	5	0	8 SOOPART, HEIKO (EST) <table border="1"><tr><td>3</td><td>5</td></tr></table>	3	5
3	5								
5	0								
3	5								
	4 PETRENKO, OLEKSANDR (UKR) <table border="1"><tr><td>0</td><td>0</td></tr></table>	0	0	7 SJÖBERG, JALMAR (SWE) <table border="1"><tr><td>0</td><td>0</td></tr></table>	0	0	6 VIIRG, PRIIT (EST) <table border="1"><tr><td>1</td><td>1</td></tr></table>	1	1
0	0								
0	0								
1	1								
Médaille de Bronze Pronksmedali võitja	2 KABULOV, ATSAMAZ (RUS)	Médaille de Bronze Pronksmedali võitja	8 SOOPART, HEIKO (EST)						

CHIEF OF OFFICIALS
CHIEF OF SECRETARY

MATI RAND
ENN TÕNISSON

KRISTJAN PALUSALU XIX MÄLESTUSVÖISTLUSED KREEKA-ROOMA MAADLUSES
TALLINN
27.-28.10.2006

Weight category **100** kg

Nr	Name / Country	Weight	Country	Pools competitions										Points Kval. Tehn.	Place	Finals competitions									Points Kval. Tehn.	Place
				1.round			2.round			3.round			1/4 final			1/2 final			Finals							
					Passivity	Time		Passivity	Time		Passivity	Time				Passivity	Time		Passivity	Time		Passivity	Time			
1.pool																										
1	KÕLUVERE, RAIVO (EST)			2	1		3	0		4	1		2										4			
					3			0			1		4													
2	LIPANIN, ALEKSEI (RUS)			1	3		4	0		3	0		3										III			
					10			0			0		10													
3	LALLI, TAISTO (FIN)			4	4		1	4		2	4		12										I			
					9			8			11		28													
4	UZDENOVA, SULTANBEK (RUS)			3	0		2	4		1	3		7										II			
					0			4			12		16													

CHIEF OF OFFICIALS	MATI RAND
CHIEF OF SECRETARY	ENN TÕNISSON

**KRISTJAN PALUSALU XIX MÄLESTUSVÖISTLUSED KREEKA-ROOMA MAADLUSES
TALLINN
27.-28.10.2006**

		55	60	66	74	84	96	120	PUNKTID	KOHT
1	EESTI	2	2	4	4	6	4 4	4 2	28	III
2	S.-PETERBURG	6	4 6		5	4	6	4	35	I
3	VENEMAA ROSSIA	1 4	4	4 6	4	4	5		31	II
4	SOOME TUL						2		2	7.-9
5	SOOME		5	5	2	2		5	19	5
6	ROOTSI	4		2	6 2	5		6	25	4
7	LÄTI					2			2	7.-9
8	LEEDU	5							5	6
9	UKRAINA							2	2	7.-9

CHIEF OF OFFICIALS MATI RAND

CHIEF OF SECRETARY ENN TÕNISSON

**KRISTJAN PALUSALU XIX MÄLESTUSVÕISTLUSED KREEKA-ROOMA
MAADLUSES
TALLINN
27.-28.10.2006**

		55 kg	60 kg	66 kg	74 kg	84 kg	96 kg	120 kg	KOKKU	KAD 100 kg	KOKKU
1	EESTI	1	1	3	1	7	2	3	18	1	19
2	SOOME	0	2	6	9	6	4	2	29	1	30
3	ROOTSI	1	1	3	2	2	1	2	12		12
4	LÄTI	0	1	2	3	3	0	0	9		9
5	LEEDU	1	0	0	0	0	1	0	2		2
6	UKRAINA	0	0	0	0	0	0	1	1		1
7	VENEMAA	3	3	3	3	2	2	1	17	2	19
									88		92

CHIEF OF OFFICIALS

MATI RAND

CHIEF OF SECRETARY

ENN TÕNISSON